

Piktogramme/pictograms



Mineralmarmor Waschtisch
Marble minerals washbasin



LED Lichtfarbe kalt
LED colour temperature cold



LED mit Bewegungssensor
LED with motion sensor



Keramik Waschtisch
Ceramic washbasin



LED Lichtfarbe warm
LED colour temperature warm



LED mit Sensorschalter
LED with sensor switch



Glas Waschtisch
Glass washbasin



LED Lichtfarbe regelbar,
Helligkeit dimmbar
LED colour temperature adjust-
able, brightness dimmable



LED Lichtfarbe schaltbar bzw. regelbar
LED colour temperature adjustable

Keramik Waschtisch weiß alpin Glanz (PEK)

Ceramic washbasin gloss alpine white (PEK)

≈ Beckenmaße in cm (BxHxT)
basin dimensions in cm (WxHxD)

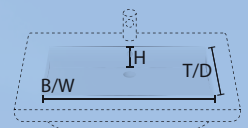

KWCHR8 | 51 x 13,5 x 32,5 cm



KWCHR10 | 51 x 13,5 x 32,5 cm



KWCHR12 | XX x 13,5 x 32,5 cm



KWCHR12D | 42 x 11,5 x 32,5 cm

Keramik Waschtisch weiß alpin Glanz mit Dekorkante (PEK) Ceramic washbasin gloss alpine white with decor edge (PEK)

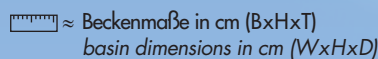
 ≈ Beckenmaße in cm (BxHxT)
basin dimensions in cm (WxHxD)

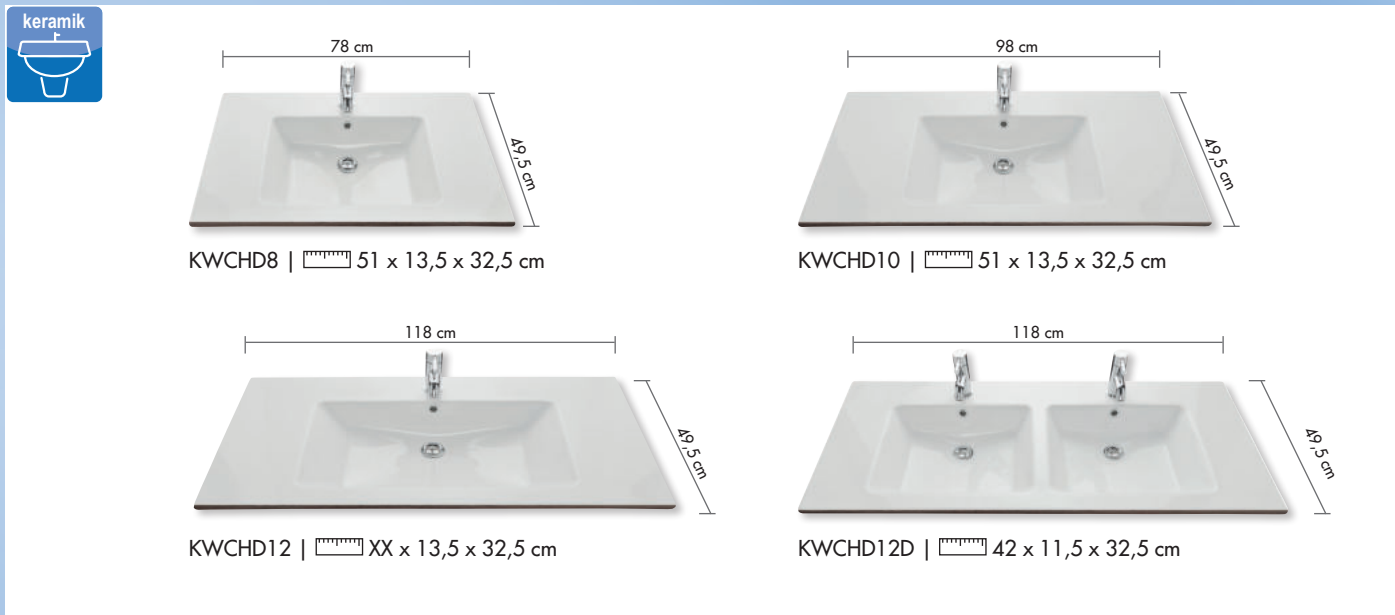
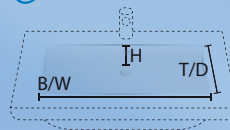

Dekorkanten-Farben/ decor edge colours



473
Eiche Struktur Nachbildung
Oak Structure Finish
PE55



284
Anthrazit Seidenglanz
Silk Gloss Anthracite
PE84



488
Robinie Dunkel Nachbildung
Robinia Dark Finish
PE58

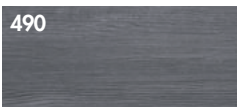

490
Kastanie Graphit Nachbildung
Graphite Chestnut Finish
PE45



Ohne Dekorkante/without decorative edge



Mit Dekorkante/with decorative edge

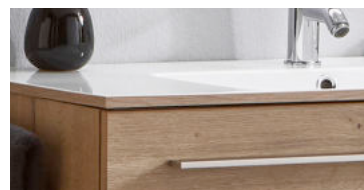

Mit Dekorkante/with decorative edge

Vorteil: PUR-Verklebung

Die Dekorkanten werden mit einem PUR-Kleber (Polyurethankleber) in einem industriellen Verfahren auf die Waschtische aufgebracht. Klebstoffe auf Polyurethan-Basis bieten vielfältige Einsatzmöglichkeiten und ein breites Spektrum an Eigenschaften für diese Anwendung:

- Dauerhaft mit hoher Scherfestigkeit
- Dauerhaft Wasserfest

Advantage: PUR bonding

The decorative edges are applied to the washbasins with a PUR glue (polyurethane adhesive) in an industrial process. Polyurethane based adhesives offer a variety of uses and a huge range of properties for this application:

- Permanently with high shear strength
- Permanently waterproof

Schränke/cabinets 3260

Frontfarben/front colours

Dickkante/thick edge

286



Weiß Seidenglanz
Silk Gloss White
PEE_

284



Anthrazit Seidenglanz
Silk Gloss Anthracite
PEA_

490



Kastanie Graphit Nachbildung
Graphite Chestnut Finish
PEC_

488



Robinie Dunkel Nachbildung
Robinia Dark Finish
PEJ_

473



Eiche Struktur Nachbildung
Oak Structure Finish
PEM_

MDF-foliiert/MDF-coated

961



Weiß Glanz
Gloss White
PEG_

438



Anthrazit Glanz
Gloss Anthracite
PEF_

Korpusfarben/basic shell colours

PG 1

286



Weiß Seidenglanz
Silk Gloss White
E/PE86

284



Anthrazit Seidenglanz
Silk Gloss Anthracite
A/PE84

490



Kastanie Graphit Nachbildung
Graphite Chestnut Finish
C/PE45

488

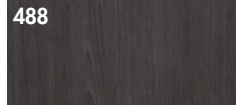

Robinie Dunkel Nachbildung
Robinia Dark Finish
J/PE58

473



Eiche Struktur Nachbildung
Oak Structure Finish
M/PE55

PG 3

042



Weiß Glanz Folie
Gloss White
G/PE50

438



Anthrazit Glanz Folie
Gloss Anthracite
F/PE30

! BITTE BEACHTEN:

Die Front-/Korpuskombination „MDF-folierte FRONT (Variante: 961/438)“ mit „Korpus PG1 (Variante: 284/286/473/488/490)“ wird zu PG2 abgerechnet.
The front / basic shell combination „MDF-foiled front (variant: 961/438)“ with „basic shell PG1 (variant: 284/286/473/488/490)“ is billed to PG2.

Regalfarben/shelf colours

	<p>287</p> <p>Weiß Seidenglanz Silk Gloss White PE86</p>		<p>285</p> <p>Anthrazit Seidenglanz Silk Gloss Anthracite PE84</p>
	<p>491</p> <p>Kastanie Graphit Nachbildung Graphite Chestnut Finish PE45</p>		<p>489</p> <p>Robinie Dunkel Nachbildung Robinia Dark Finish PE58</p>
	<p>474</p> <p>Eiche Struktur Nachbildung Oak Structure Finish PE55</p>		

Griffe/handles

⊕—⊕ = Bohrabstand/hole spacing



Edelstahl Optik
Stainless design

265/266/267/268/269/270/386

⊕—⊕ 96 mm/128 mm/128-192-128 mm/179-192-179 mm/179-192-179 mm/279-192-279 mm/192-256 mm



Schwarz Matt Struktur
Matt Black Structure

272/273/274/275/276/277/271

⊕—⊕ 96 mm/128 mm/128-192-128 mm/179-192-179 mm/179-192-179 mm/279-192-279 mm/192-256 mm

Beleuchtung / lighting



Aufbauleuchte LED
Top light LED

Lichfarbe Tageslicht (Kalt)
Luminous colour natural light (cold)



AW80, AWP90,
AW100,
AW120, AWP120



Seitlich und oben LED Beleuchtung
lateral and top LED lighting











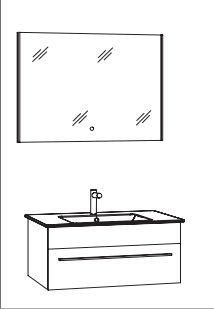



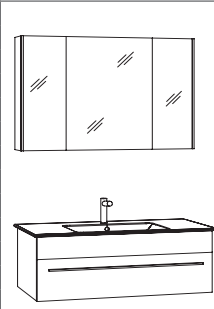

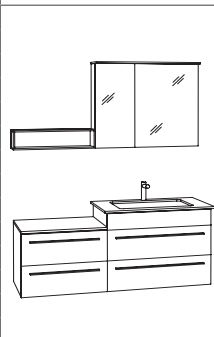

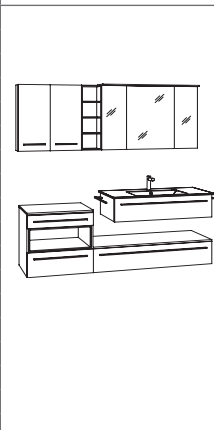



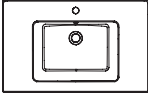

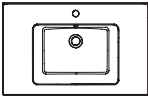
Die Steckdose / Powerbox ist auch in Ausführung für die Schweiz / Frankreich erhältlich. Bitte Mehrpreis beachten (siehe Zubehör Seite 1).
The power socket is also available for Switzerland / France. Please note extra charge (see accessories page 1).

3260 »Beispiel-Kombinationen/example-combinations«

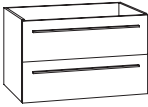
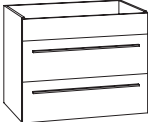
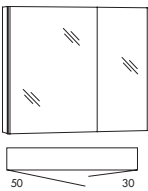
Beschreibung Description	Maße in cm Dimensions in cm			Artikel-Nr. Article no.	Türanschlag Door stop	Identnummer ID number
	B/W	H	T/D			

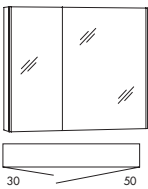

PG1 Dickkante/ thick edge	PG2 Matt/matt	PG3 Glanz/gloss
---------------------------------	------------------	--------------------

	<p>Kombination 80 cm bestehend aus: Spiegelpaneel, Sensorschalter Keramik-Waschtisch Waschtisch-Unterschrank, 1 feste Blende, 1 Auszug</p> <p><i>combination 80 cm width consisting of: mirror panel, sensor switch ceramics washbasin washbasin base cabinet, 1 fixed cover, 1 extension</i></p>	<p>SPBSA9 KWCHR8 WKHBS7</p>   			
	<p>Kombination 100 cm bestehend aus: Spiegelschrank, seitliche LED-Beleuchtung Keramik-Waschtisch Waschtisch-Unterschrank, 1 feste Blende, 1 Auszug 1 Tür links</p> <p><i>combination 100 cm width consisting of: mirror cabinet, lateral LED-lighting ceramics washbasin washbasin base cabinet, 1 fixed cover, 1 extension</i></p>	<p>SADA10 KWCHR10 WKHBS9</p>  			
	<p>Kombination 140 cm bestehend aus: Spiegelschrank, seitliche LED-Beleuchtung Regal neben dem Spiegelschrank Keramik-Waschtisch Waschtisch-Unterschrank, 1 Schubkasten, 1 Auszug Unterschrank, 2 Auszüge</p> <p><i>combination 140 cm width consisting of: mirror cabinet, lateral LED-lighting shelf lateral mirror cabinet ceramics washbasin, depot right washbasin base cabinet, 1 drawer, 1 extension base cabinet, 2 extensions</i></p>	<p>SADA8R SRB6 KWCHR8 WKHBSA7 UHAA6F</p>  			
	<p>Kombination 180 cm bestehend aus: Spiegelschrank, seitliche LED-Beleuchtung Regal neben dem Spiegelschrank Keramik-Waschtisch Waschtisch-Unterschrank, 1 Schubkasten Unterschrank, 1 Auszug Unterschrank, 1 Schubkasten, 1 Einschubregal, 1 Auszug Oberschrank, 2 Türen</p> <p><i>combination 180 cm width consisting of: mirror cabinet, lateral LED-lighting shelf lateral mirror cabinet ceramics washbasin washbasin base cabinet, 1 drawer base cabinet, 1 extension base cabinet, 1 drawer, 1push-in shelf, 1 extension top cabinet, 2 doors</i></p>	<p>SADA10 REB20 KWCHR10 WKHS9 UHA11F UHSEA6F OT60D</p>  			

Beschreibung Description	Maße in cm Dimensions in cm			Artikel-Nr. Article no.	Türanschlag Door stop	Identnummer ID number	
	B/W	H	T/D				
 Keramik-Waschtisch inkl. Überlauf <i>ceramic washbasin incl. overflow</i>	81	1,5	51	KWCHR8 			
 Keramik-Waschtisch mit Dekorkante inkl. Überlauf <i>ceramic washbasin with decor edge incl. overflow</i>	78	1,5	49,5	KWCHD8 			
					PG1 Dickkante/ thick edge	PG2 Matt/matt	PG3 Glanz/gloss
 Waschtisch-Unterschrank 1 Schubkasten <i>washbasin base cabinet 1 drawer</i>	77	23,8	49,3	WKHS7			
 Waschtisch-Unterschrank 1 feste Blende, 1 Schubkasten <i>washbasin base cabinet 1 fixed cover, 1 drawer</i>	77	36,6	49,3	WKHBS7			
 Waschtisch-Unterschrank 1 Schubkasten, 1 Auszug <i>washbasin base cabinet 1 drawer, 1 extension</i>	77	47,8	49,3	WKHSA7			
 Waschtisch-Unterschrank 1 feste Blende, 1 Schubkasten, 1 Auszug <i>washbasin base cabinet 1 fixed cover, 1 drawer, 1 extension</i>	77	60,6	49,3	WKHBSA7			
 Spiegelschrank, 2 vollflächig verspiegelte Türen, 2 Glaseinlegeböden, seitliche LED-Beleuchtung 12,4 W, 6000 Kelvin inkl. Schalter/Steckdose, EEK A-A++ <i>mirror cabinet, 2 full mirrored doors 2 glass boards, lateral LED-lighting 12,4 W, 6000 Kelvin incl. switch/socket, EEC A-A++</i>	80	68,2	17,6	SADA8L 			
 Spiegelschrank, 2 vollflächig verspiegelte Türen, 2 Glaseinlegeböden, seitliche LED-Beleuchtung 12,4 W, 6000 Kelvin inkl. Schalter/Steckdose, EEK A-A++ <i>mirror cabinet, 2 full mirrored doors 2 glass boards, lateral LED-lighting 12,4 W, 6000 Kelvin incl. switch/socket, EEC A-A++</i>	80	68,2	17,6	SADA8R 			
 LED-Aufbauleuchte für Spiegelschrank mit LED-Mini-Stecker, 10,8 W, 6000 Kelvin, ohne Schalter, EEK A-A++ <i>LED-lighting for mirror cabinet with LED-mini-plug, 10,8 W, 6000 Kelvin, without switch EEC A-A++</i>	80	2,4	20	AW80 			



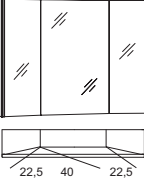
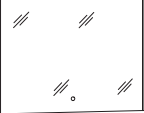

EEK/EEC=Energyeffizienzklasse/energy efficiency category



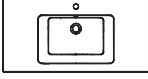

 Dekorkantenfarben unbedingt mit angeben, Übersicht siehe Seite 2. Please indicate decor edge colours, overview see page 2.

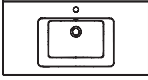



Beschreibung Description	Maße in cm Dimensions in cm			Artikel-Nr. Article no.	Türanschlag Door stop	Identnummer ID number
	B/W	H	T/D			
 <p>Spiegelschrank, 3 Spiegeltüren davon 2 trapezförmig angeordnet, 6 Glaseinlegeböden, seitlich und oben LED-Beleuchtung, 19,8 W, 6000 Kelvin, inkl. Schalter/Steckdose, EEK A–A++</p> <p><i>mirror cabinet, 3 mirror doors, 2 of them are arranged in a trapeze, 6 glass shelves, lateral and top LED lighting 19,8 W, 6000 Kelvin incl. switch/socket, EEC A–A++</i></p>	80	68,2	17,5	SDU8		
 <p>Spiegelschrank, 3 Spiegeltüren davon 2 trapezförmig angeordnet, 6 Glaseinlegeböden, seitlich und oben LED-Beleuchtung, 20,8 W, 6000 Kelvin, inkl. Schalter/Steckdose, EEK A–A++</p> <p><i>mirror cabinet, 3 mirror doors, 2 of them are arranged in a trapeze, 6 glass shelves, lateral and top LED lighting 20,8 W, 6000 Kelvin incl. switch/socket, EEC A–A++</i></p>	90	68,2	17,5	SDU9		
 <p>Spiegelpaneel, Sensorschalter, seitliche LED-Beleuchtung 2x 6,2 W 6000 Kelvin EEK A–A++</p> <p><i>mirror panel, sensor switch lateral LED-lighting 2x 6,2 W, 6000 Kelvin EEC A–A++</i></p>	90	68,2	2,8	SPBSA9		
 <p>LED-Aufbauleuchte für Spiegelpaneel mit LED-Mini-Stecker, 12,2 W, 6000 Kelvin, ohne Schalter EEK A–A++</p> <p><i>LED-lighting for mirror panel with LED-mini-plug, 12,2 W, 6000 Kelvin, without switch EEC A–A++</i></p>	90	2,4	10	AWP90		

EEK/EEC=Energieeffizienzklasse/energy efficiency category



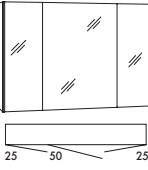



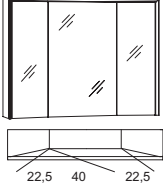

Beschreibung Description	Maße in cm Dimensions in cm			Artikel-Nr. Article no.	Türanschlag Door stop	Identnummer ID number
	B/W	H	T/D			

	Keramik-Waschtisch inkl. Überlauf ceramic washbasin incl. overflow	101	1,5	51	KWCHR10				
	Keramik-Waschtisch mit Dekorkante inkl. Überlauf ceramic washbasin with decor edge incl. overflow	98	1,5	49,5	KWCHD10				

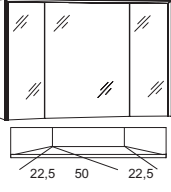

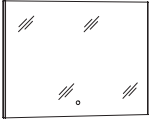







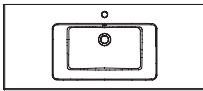

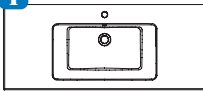
							PG1 Dickkante/ thick edge	PG2 Matt/matt	PG3 Glanz/gloss
	Waschtisch-Unterschrank 1 Schubkasten washbasin base cabinet 1 drawer	97	23,8	49,3	WKHS9				
	Waschtisch-Unterschrank 1 feste Blende, 1 Schubkasten washbasin base cabinet 1 fixed cover, 1 drawer	97	36,6	49,3	WKHBS9				
	Waschtisch-Unterschrank 1 Schubkasten, 1 Auszug washbasin base cabinet 1 drawer, 1 extensioin	97	47,8	49,3	WKHSA9				
	Waschtisch-Unterschrank 1 feste Blende, 1 Schubkasten, 1 Auszug washbasin base cabinet 1 fixed cover, 1 drawer, 1 extension	97	60,6	49,3	WKHBSA9				

	Spiegelschrank, 3 vollflächig verspiegelte Türen, 4 Glaseinlegeböden, seitliche LED-Beleuchtung 12,4 W, 6000 Kelvin inkl. Schalter/Steckdose EEK A-A++ mirror cabinet, 3 full mirrored doors 4 glass boards, lateral LED-lighting 12,4 W, 6000 Kelvin incl. switch/socket EEC A-A++	100	68,2	17,6	SADA10				
	LED-Aufbauleuchte für Spiegelschrank mit LED-Mini-Stecker, 13,7 W, 6000 Kelvin, ohne Schalter, EEK A-A++ LED-lighting for mirror cabinet with LED-mini-plug, 13,7 W, 6000 Kelvin, without switch, EEC A-A++	100	2,4	20	AW100				

 Dekorkantenfarben unbedingt mit angeben, Übersicht siehe Seite 2. Please indicate decor edge colours, overview see page 2.

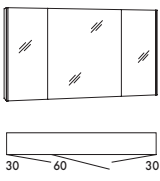

Beschreibung Description	Maße in cm Dimensions in cm			Artikel-Nr. Article no.	Türanschlag Door stop	Identnummer ID number
	B/W	H	T/D			
 <p>Spiegelschrank, 3 Spiegeltüren davon 2 trapezförmig angeordnet, 6 Glaseinlegeböden, seitlich und oben LED-Beleuchtung, 20,8 W, 6000 Kelvin, inkl. Schalter/Steckdose, EEK A–A++</p> <p><i>mirror cabinet, 3 mirror doors, 2 of them are arranged in a trapeze, 6 glass shelves, lateral and top LED lighting 20,8 W, 6000 Kelvin incl. switch/socket, EEC A–A++</i></p>	90	68,2	17,5	SDU9		
 <p>Spiegelschrank, 3 Spiegeltüren davon 2 trapezförmig angeordnet, 6 Glaseinlegeböden, seitlich und oben LED-Beleuchtung, 21,9 W, 6000 Kelvin, inkl. Schalter/Steckdose, EEK A–A++</p> <p><i>mirror cabinet, 3 mirror doors, 2 of them are arranged in a trapeze, 6 glass shelves, lateral and top LED lighting 21,9 W, 6000 Kelvin incl. switch/socket, EEC A–A++</i></p>	100	68,2	17,5	SDU10		
 <p>Spiegelpaneel, Sensorschalter, seitliche LED-Beleuchtung 2x 6,2 W, 6000 Kelvin EEK A–A++</p> <p><i>mirror panel, sensor switch, lateral LED-lighting 2x 6,2 W, 6000 Kelvin EEC A–A++</i></p>	90	68,2	2,8	SPBSA9	 	
 <p>LED-Aufbauleuchte für Spiegelpaneel mit LED-Mini-Stecker, 12,2 W, 6000 Kelvin, ohne Schalter EEK A–A++</p> <p><i>LED-lighting for mirror panel with LED-mini-plug, 12,2 W, 6000 Kelvin, without switch EEC A–A++</i></p>	90	2,4	10	AWP90		

EEK/EEC=Energieeffizienzklasse/energy efficiency category

Beschreibung Description	Maße in cm Dimensions in cm			Artikel-Nr. Article no.	Türanschlag Door stop	Identnummer ID number			
	B/W	H	T/D				PG1 Dickkante/ thick edge	PG2 Matt/matt	PG3 Glanz/gloss
 Keramik-Waschtisch inkl. Überlauf ceramic washbasin incl. overflow	121	1,5	51	KWCHR12					
 i Keramik-Waschtisch mit Dekorkante inkl. Überlauf ceramic washbasin with decor edge incl. overflow	118	1,5	49,5	KWCHD12					
 Waschtisch-Unterschrank 1 Schubkasten washbasin base cabinet 1 drawer	117	23,8	49,3	WKHS11					
 Waschtisch-Unterschrank 1 feste Blende, 1 Schubkasten washbasin base cabinet 1 fixed cover, 1 drawer	117	36,6	49,3	WKHBS11					
 Waschtisch-Unterschrank 1 Schubkasten, 1 Auszug washbasin base cabinet 1 drawer, 1 extension	117	47,8	49,3	WKHSA11					
 Waschtisch-Unterschrank 1 feste Blende, 1 Schubkasten, 1 Auszug washbasin base cabinet 1 fixed cover, 1 drawer, 1 extension	117	60,6	49,3	WKHBSA11					
 Spiegelschrank, 3 vollflächig verspiegelte Türen, 6 Glaseinlegeböden, seitliche LED-Beleuchtung 12,4 W, 6000 Kelvin inkl. Schalter/Steckdose EEK A-A++ mirror cabinet, 3 full mirrored doors 6 glass boards, lateral LED-lighting 12,4 W, 6000 Kelvin incl. switch/socket EEC A-A++	120	68,2	17,6	SADA12					
 LED-Aufbauleuchte für Spiegelschrank mit LED-Mini-Stecker, 16,6 W, 6000 Kelvin, ohne Schalter EEK A-A++ LED-lighting for mirror cabinet with LED-mini-plug, 16,6 W, 6000 Kelvin, without switch EEC A-A++	120	2,4	20	AW120					



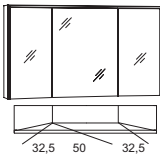
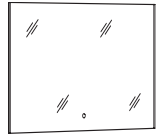

EEK/EEC=Energieeffizienzklasse/energy efficiency category



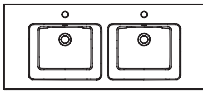

i Dekorkantenfarben unbedingt mit angeben, Übersicht siehe Seite 2. Please indicate decor edge colours, overview see page 2.

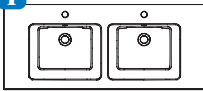



Beschreibung Description	Maße in cm Dimensions in cm			Artikel-Nr. Article no.	Türanschlag Door stop	Identnummer ID number
	B/W	H	T/D			
 <p>Spiegelschrank, 3 Spiegeltüren davon 2 trapezförmig angeordnet, 6 Glaseinlegeböden, seitlich und oben LED-Beleuchtung, 23,6 W, 6000 Kelvin, inkl. Schalter/Steckdose, EEK A–A++</p> <p><i>mirror cabinet, 3 mirror doors, 2 of them are arranged in a trapeze, 6 glass shelves, lateral and top LED lighting 23,6 W, 6000 Kelvin incl. switch/socket, EEC A–A++</i></p>	120	68,2	17,5	SDU12		
 <p>Spiegelpaneel, Sensorschalter seitliche LED-Beleuchtung 2x 6,2 W 6000 Kelvin, EEK A–A++</p> <p><i>mirror panel, sensor switch lateral LED-lighting 2x 6,2 W 6000 Kelvin, EEC A–A++</i></p>	120	68,2	2,8	SPBSA12		
 <p>LED-Aufbauleuchte für Spiegelpaneel mit LED-Mini-Stecker, 16,9 W, 6000 Kelvin, ohne Schalter EEK A–A++</p> <p><i>LED-lighting for mirror panel with LED-mini-plug, 16,9 W, 6000 Kelvin, without switch EEC A–A++</i></p>	120	2,4	10	AWP120		

EEK/EEC=Energieeffizienzklasse/energy efficiency category

Beschreibung Description	Maße in cm Dimensions in cm			Artikel-Nr. Article no.	Türanschlag Door stop	Identnummer ID number
	B/W	H	T/D			

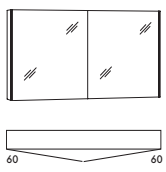





	Keramik-Doppel-Waschtisch inkl. Überlauf <i>ceramic double washbasin incl. overflow</i>	121	1,5	51	KWCHR12D 	
	Keramik-Doppel-Waschtisch mit Dekor- kante , inkl. Überlauf <i>ceramic double washbasin with decor edge, incl. overflow</i>	118	1,5	49,5	KWCHD12D 	

						PG1 Dickkante/ thick edge	PG2 Matt/matt	PG3 Glanz/gloss
	Waschtisch-Unterschrank für Doppelwaschtisch 1 Schubkasten <i>washbasin base cabinet for double washbasin 1 drawer</i>	117	23,8	49,3	WKHS11D			
	Waschtisch-Unterschrank für Doppelwaschtisch 1 feste Blende, 1 Schubkasten <i>washbasin base cabinet for double washbasin 1 fixed cover, 1 drawer</i>	117	36,6	49,3	WKHBS11D			
	Waschtisch-Unterschrank für Doppelwaschtisch 1 Schubkasten, 1 Auszug <i>washbasin base cabinet for double washbasin 1 drawer, 1 extension</i>	117	47,8	49,3	WKHSA11D			
	Waschtisch-Unterschrank für Doppelwaschtisch 1 feste Blende, 1 Schubkasten, 1 Auszug <i>washbasin base cabinet for double washbasin 1 fixed cover, 1 drawer, 1 extension</i>	117	60,6	49,3	WKHBSA11D			

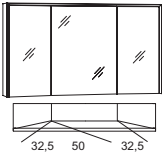
	Spiegelschrank, 2 vollflächig verspiegelte Türen, 4 Glaseinlegeböden, seitliche LED-Beleuchtung 12,4 W, 6000 Kelvin inkl. Schalter/Steckdose EEK A-A++ <i>mirror cabinet, 2 full mirrored doors 4 glass boards, lateral LED-lighting 12,4 W, 6000 Kelvin incl. switch/socket EEC A-A++</i>	120	68,2	17,6	SADA12D 			
	LED-Aufbauleuchte für Spiegelschrank mit LED-Mini-Stecker, 16,6 W, 6000 Kelvin, ohne Schalter EEK A-A++ <i>LED-lighting for mirror cabinet with LED-mini-plug, 16,6 W, 6000 Kelvin, without switch EEC A-A++</i>	120	2,4	20	AW120 			

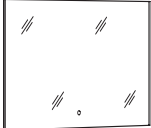
EEK/EEC=Energieeffizienzklasse/energy efficiency category

 Dekorkantenfarben unbedingt mit angeben, Übersicht siehe Seite 2. Please indicate decor edge colours, overview see page 2.

Beschreibung Description	Maße in cm Dimensions in cm			Artikel-Nr. Article no.	Türanschlag Door stop	Identnummer ID number
	B/W	H	T/D			
 <p>Spiegelschrank, 3 Spiegeltüren davon 2 trapezförmig angeordnet, 6 Glaseinlegeböden, seitlich und oben LED-Beleuchtung, 23,6 W, 6000 Kelvin, inkl. Schalter/Steckdose, EEK A–A++</p> <p><i>mirror cabinet, 3 mirror doors, 2 of them are arranged in a trapeze, 6 glass shelves, lateral and top LED lighting 23,6 W, 6000 Kelvin incl. switch/socket, EEC A–A++</i></p>	120	68,2	17,5	SDU12		
						
 <p>Spiegelpaneel, Sensorschalter seitliche LED-Beleuchtung 2x 6,2 W 6000 Kelvin, EEK A–A++</p> <p><i>mirror panel, sensor switch lateral LED-lighting 2x 6,2 W 6000 Kelvin, EEC A–A++</i></p>	120	68,2	2,8	SPBSA12		
				 		
 <p>LED-Aufbauleuchte für Spiegelpaneel mit LED-Mini-Stecker, 16,9 W, 6000 Kelvin, ohne Schalter EEK A–A++</p> <p><i>LED-lighting for mirror panel with LED-mini-plug, 16,9 W, 6000 Kelvin, without switch EEC A–A++</i></p>	120	2,4	10	AWP120		
						









EEK/EEC=Energieeffizienzklasse/energy efficiency category

3260 »Unterschranke mit Abdeckplatte/base cabinets with cover plaid«







	Beschreibung Description	Maße in cm Dimensions in cm			Artikel-Nr. Article no.	Türanschlag Door stop	Identnummer ID number		
		B/W	H	T/D			PG1 Dickkante/ thick edge	PG2 Matt/matt	PG3 Glanz/gloss
	Unterschrank inkl. Abdeckplatte 1 Auszug <i>base cabinet incl. top 1 extension</i>	40	25,6	49,3	UHA4F				
	Unterschrank inkl. Abdeckplatte 1 Schubkasten, 1 Auszug <i>base cabinet incl. top 1 drawer, 1 extension</i>	40	38,4	49,3	UHSA4F				
	Unterschrank inkl. Abdeckplatte 2 Auszüge <i>base cabinet incl. top 2 extensions</i>	40	49,6	49,3	UHAA4F				
	Unterschrank inkl. Abdeckplatte 1 Schubkasten, 2 Auszüge <i>sideboard incl. top 1 drawer, 2 extensions</i>	40	62,4	49,3	UHSA4F				
	 Unterschrank inkl. Abdeckplatte 1 Schubkasten, 1 Einschubregal, 1 Auszug <i>sideboard incl. top 1 drawer, 1 push-in shelf, 1 extension</i>	40	62,4	49,3	UHSEA4F				
	Unterschrank inkl. Abdeckplatte 1 Auszug <i>base cabinet incl. top 1 extension</i>	60	25,6	49,3	UHA6F				
	Unterschrank inkl. Abdeckplatte 1 Schubkasten, 1 Auszug <i>base cabinet incl. top 1 drawer, 1 extension</i>	60	38,4	49,3	UHSA6F				
	Unterschrank inkl. Abdeckplatte 2 Auszüge <i>base cabinet incl. top 2 extensions</i>	60	49,6	49,3	UHAA6F				
	Unterschrank inkl. Abdeckplatte 1 Schubkasten, 2 Auszüge <i>sideboard incl. top 1 drawer, 2 extensions</i>	60	62,4	49,3	UHSA6F				
	 Unterschrank inkl. Abdeckplatte 1 Schubkasten, 1 Einschubregal, 1 Auszug <i>sideboard incl. top 1 drawer, 1 push-in shelf, 1 extension</i>	60	62,4	49,3	UHSEA6F				

 Regalfarben unbedingt mit angeben, Übersicht siehe Seite 4. Please indicate shelf colours, overview see page 4.

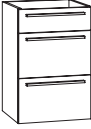
3260 »Unterschranke mit Abdeckplatte/base cabinets with cover plaid«







Beschreibung Description	Maße in cm Dimensions in cm			Artikel-Nr. Article no.	Türanschlag Door stop	Identnummer ID number		
	B/W	H	T/D			PG1 Dickkante/ thick edge	PG2 Matt/matt	PG3 Glanz/gloss
 <p>Unterschrank inkl. Abdeckplatte 1 Auszug <i>base cabinet incl. top 1 extension</i></p>	97	25,6	49,3	UHA9F				
 <p>Unterschrank inkl. Abdeckplatte 1 Schubkasten, 1 Auszug <i>base cabinet incl. top 1 drawer, 1 extension</i></p>	97	38,4	49,3	UHSA9F				
 <p>Unterschrank inkl. Abdeckplatte 2 Auszüge <i>base cabinet incl. top 2 extensions</i></p>	97	49,6	49,3	UHAA9F				
 <p>Unterschrank inkl. Abdeckplatte 1 Schubkasten, 2 Auszüge <i>sideboard incl. top 1 drawer, 2 extensions</i></p>	97	62,4	49,3	UHSAA9F				
 <p>Unterschrank inkl. Abdeckplatte 1 Auszug <i>base cabinet incl. top 1 extension</i></p>	117	25,6	49,3	UHA11F				
 <p>Unterschrank inkl. Abdeckplatte 1 Schubkasten, 1 Auszug <i>base cabinet incl. top 1 drawer, 1 extension</i></p>	117	38,4	49,3	UHSA11F				
 <p>Unterschrank inkl. Abdeckplatte 2 Auszüge <i>base cabinet incl. top 2 extensions</i></p>	117	49,6	49,3	UHAA11F				
 <p>Unterschrank inkl. Abdeckplatte 1 Schubkasten, 2 Auszüge <i>sideboard incl. top 1 drawer, 2 extensions</i></p>	117	62,4	49,3	UHSAA11F				

3260 »Unterschranke ohne Abdeckplatte/base cabinets without cover plaid«

Beschreibung Description	Maße in cm Dimensions in cm			Artikel-Nr. Article no.	Türanschlag Door stop	Identnummer ID number		
	B/W	H	T/D			PG1 Dickkante/ thick edge	PG2 Matt/matt	PG3 Glanz/gloss
 <p>Unterschrank ohne Abdeckplatte 1 Schubkasten, 2 Auszüge</p> <p><i>base cabinet without top 1 drawer, 2 extensions</i></p>	40,0	60,6	35,0	UHSAA4				
		NEW						
 <p>Unterschrank ohne Abdeckplatte 1 Schubkasten, 1 Einschubregal, 1 Auszug</p> <p><i>base cabinet without top 1 drawer, 1 push-in shelf, 1 extension</i></p>	40,0	60,6	35,0	UHSEA4				
		NEW						
 <p>Unterschrank ohne Abdeckplatte 1 Schubkasten, 2 Auszüge</p> <p><i>base cabinet without top 1 drawer, 2 extensions</i></p>	60,0	60,6	35,0	UHSAA6				
		NEW						
 <p>Unterschrank ohne Abdeckplatte 1 Schubkasten, 1 Einschubregal, 1 Auszug</p> <p><i>base cabinet without top 1 drawer, 1 push-in shelf, 1 extension</i></p>	60,0	60,6	35,0	UHSEA6				
		NEW						
 <p>Unterschrank ohne Abdeckplatte 1 Schubkasten, 2 Auszüge</p> <p><i>base cabinet without top 1 drawer, 2 extensions</i></p>	97,0	60,6	35,0	UHSAA9				
		NEW						
 <p>Unterschrank ohne Abdeckplatte 1 Schubkasten, 2 Auszüge</p> <p><i>base cabinet without top 1 drawer, 2 extensions</i></p>	117,0	60,6	35,0	UHSAA11				
		NEW						
 <p>Maßvariable Abdeckplatte für Unterschranke ohne Abdeckplatte</p> <p><i>cover panel in variable dimensions for base cabinets without top</i></p>	117,0 max.	1,6	49,3 max.	ADFV				
		NEW						
Artikel nicht lieferbar in Weiß Glanz und Anthrazit Glanz / article not available in White Gloss and Anthracite Gloss								

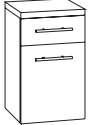
 Regalfarben unbedingt mit angeben, Übersicht siehe Seite 4. Please indicate shelf colours, overview see page 4.

3260 »Beistellschränke/ side cabinets«

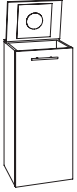
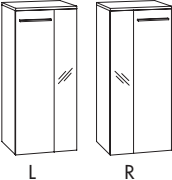
Beschreibung Description	Maße in cm Dimensions in cm			Artikel-Nr. Article no.	Türanschlag Door stop	Identnummer ID number		
	B/W	H	T/D			PG1 Dickkante/ thick edge	PG2 Matt/matt	PG3 Glanz/gloss
 <p>Oberschrank 1 Tür 2 Glaseinlegeböden</p> <p><i>top cabinet 1 door 2 glass boards</i></p>	40	68,2	17,4	OT40DL OT40DR	Links/ <i>left</i> Rechts/ <i>right</i>			
	40	68,2	13,4	OLT4L OLT4R	Links/ <i>left</i> Rechts/ <i>right</i>			
 <p>Oberschrank 2 Türen 2 Glaseinlegeböden</p> <p><i>top cabinet 2 doors 2 glass boards</i></p>	60	68,2	17,4	OT60D				
	60	68,2	13,4	OLT6				
 <p>Unterschrank inkl. Abdeckplatte 1 Tür, 1 Schubkasten</p> <p><i>base cabinet incl. top 1 door, 1 drawer</i></p>	40	49,6	34,8	UST4FL UST4FR	Links/ <i>left</i> Rechts/ <i>right</i>			
 <p>Highboard inkl. Abdeckplatte 1 Tür 2 Glaseinlegeböden</p> <p><i>high cabinet incl. top 1 door 2 glass boards</i></p>	30	91,2	34,8	HBT3FL HBT3FR	Links/ <i>left</i> Rechts/ <i>right</i>			
	40	91,2	17,4	HBFT4FL HBFT4FR	Links/ <i>left</i> Rechts/ <i>right</i>			
	40	91,2	34,8	HBT4FL HBT4FR	Links/ <i>left</i> Rechts/ <i>right</i>			
 <p>Highboard inkl. Abdeckplatte 1 Tür, 1 Schubkasten 2 Glaseinlegeböden</p> <p><i>high cabinet incl. top 1 door, 1 drawer 2 glass boards</i></p>	40	91,2	34,8	HBST4FL HBST4FR	Links/ <i>left</i> Rechts/ <i>right</i>			
 <p>Highboard inkl. Abdeckplatte 1 Tür/Wäschekippe</p> <p><i>high cabinet incl. top 1 door/linen bin</i></p>	40	91,2	34,8	HBW4F				
 <p>Schminkschrank inkl. Deckel 1 Tür, 1 Klappe 2 Glaseinlegeböden Kosmetikeinsatz & Vergrößerungsspiegel</p> <p><i>make-up cabinet incl. lid 1 door, 1 flap door 2 glass boards cosmetic insert part & magnifying mirror</i></p>	40	91,2	34,8	HBKT4L HBKT4R	Links/ <i>left</i> Rechts/ <i>right</i>			
 <p>Highboard inkl. Abdeckplatte 1 Tür Kombination Holz/satiniertes Glas 2 Glaseinlegeböden</p> <p><i>high cabinet incl. top 1 door combination wood/frosted glass 2 glass boards</i></p> <p>L R</p>	40	91,2	34,8	HBG4FL HBG4FR	Links/ <i>left</i> Rechts/ <i>right</i>			

3260 »Beistellschränke/ side cabinets«

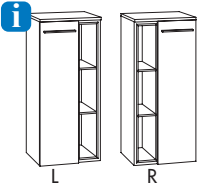
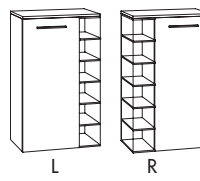
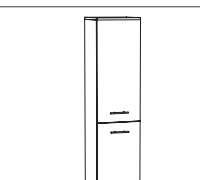
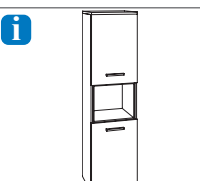
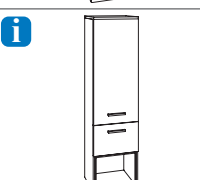
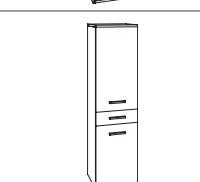
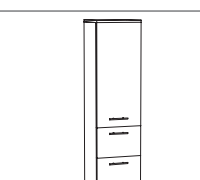
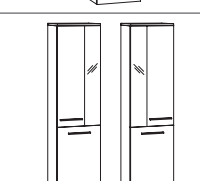
Beschreibung Description	Maße in cm Dimensions in cm			Artikel-Nr. Article no.	Türanschlag Door stop	Identnummer ID number		
	B/W	H	T/D			PG1 Dickkante/ thick edge	PG2 Matt/matt	PG3 Glanz/gloss
 <p>Highboard inkl. Abdeckplatte 1 Tür, 1 Einschubregal 2 Glaseinlegeböden</p> <p><i>high cabinet incl. top 1 door, 1 push-in shelf 2 glass boards</i></p>	40	91,2	34,8	HBTR4FL HBTR4FR	Links/left Rechts/right			
 <p>Highboard inkl. Abdeckplatte 1 Tür, 2 Glaseinlegeböden 1 seitliches Glasregal, 5 Glasböden</p> <p><i>high cabinet incl. top 1 door, 2 glass boards 1 lateral glass shelf, 5 glass boards</i></p>	55	91,2	34,8	HBTR55FL HBTR55FR	Links/left Rechts/right			
 <p>Mittelschrank inkl. Abdeckplatte 2 Türen 3 Glaseinlegeböden</p> <p><i>medium cabinet incl. top 2 doors 3 glass boards</i></p>	30 40	148,8	34,8	MTT3FL MTT3FR MTT4FL MTT4FR	Links/left Rechts/right Links/left Rechts/right			
 <p>Mittelschrank inkl. Abdeckplatte 2 Türen, 1 Einschubregal 2 Glaseinlegeböden</p> <p><i>medium cabinet incl. top 2 doors, 1 push-in shelf 2 glass boards</i></p>	40	148,8	34,8	MTET4FL MTET4FR	Links/left Rechts/right			
 <p>Mittelschrank inkl. Abdeckplatte 1 Tür, 1 Auszug, 1 Einschubregal 2 Glaseinlegeböden</p> <p><i>medium cabinet incl. top 1 door, 1 extension, 1 push-in shelf 2 glass boards</i></p>	40	148,8	34,8	MTAE4FL MTAE4FR	Links/left Rechts/right			
 <p>Mittelschrank inkl. Abdeckplatte 2 Türen, 1 Schubkasten 3 Glaseinlegeböden</p> <p><i>medium cabinet incl. top 2 doors, 1 drawer 3 glass boards</i></p>	40	148,8	34,8	MTST4FL MTST4FR	Links/left Rechts/right			
 <p>Mittelschrank inkl. Abdeckplatte 1 Tür, 2 Auszüge 2 Glaseinlegeböden</p> <p><i>medium cabinet incl. top 1 door, 2 extensions 2 glass boards</i></p>	40	148,8	34,8	MTAA4FL MTAA4FR	Links/left Rechts/right			
 <p>Mittelschrank inkl. Abdeckplatte 1 Tür, 1 Tür Kombination Holz/satiniertes Glas, 3 Glaseinlegeböden</p> <p><i>medium cabinet incl. top 1 door, 1 door combination wood/ frosted glass, 3 glass boards</i></p>	40	148,8	34,8	MGT4FL MGT4FR	Links/left Rechts/right			

EEK/EEC=Energieeffizienzklasse/energy efficiency category

 Regalfarben unbedingt mit angeben, Übersicht siehe Seite 4. Please indicate shelf colours, overview see page 4.







3260 »Beistellschränke/ side cabinets«

Beschreibung Description	Maße in cm Dimensions in cm			Artikel-Nr. Article no.	Türanschlag Door stop	Identnummer ID number		
	B/W	H	T/D			PG1 Dickkante/ thick edge	PG2 Matt/matt	PG3 Glanz/gloss
 <p>Mittelschrank inkl. Abdeckplatte 2 Türen, 1 Einschubregal 3 Glaseinlegeböden</p> <p><i>medium cabinet incl. top 2 doors, 1 push-in shelf 3 glass boards</i></p>	40	148,8	34,8	MTRT4FL MTRT4FR	Links/ <i>left</i> Rechts/ <i>right</i>			
 <p>Mittelschrank inkl. Abdeckplatte 2 Türen, 3 Glaseinlegeböden 1 seitl. Glasregal, 7 Glasböden</p> <p><i>medium cabinet incl. top 2 doors, 3 glass boards 1 lateral glass shelf, 7 glass boards</i></p>	55	148,8	34,8	MTTGR55FL MTTGR55FR	Links/ <i>left</i> Rechts/ <i>right</i>			
 <p>Mittelschrank inkl. Abdeckplatte 4 Türen 3 Glaseinlegeböden</p> <p><i>medium cabinet incl. top 4 doors 3 glass boards</i></p>	60	148,8	34,8	MTT6F				
 <p>Mittelschrank inkl. Abdeckplatte 4 Türen, 1 Schubkasten 3 Glaseinlegeböden</p> <p><i>medium cabinet incl. top 4 doors, 1 drawer 3 glass boards</i></p>	60	148,8	34,8	MTST6F				
 <p>Mittelschrank inkl. Abdeckplatte 2 Türen, 2 Auszüge 2 Glaseinlegeböden</p> <p><i>medium cabinet incl. top 2 doors, 2 extensions 2 glass boards</i></p>	60	148,8	34,8	MTAA6F				
 <p>Kombi-Mittelschrank inkl. Abdeckplatte 1 Tür, 1 Nische, 1 Auszug 2 Glaseinlegeböden</p> <p><i>medium cabinet incl. top 1 door, 1 open case, 1 extension 2 glass boards</i></p>	40	148,8	17,6/ 34,8	MTNA4FL MTNA4FR	Links/ <i>left</i> Rechts/ <i>right</i>			
 <p>Kombi-Mittelschrank inkl. Abdeckplatte 1 Tür, 1 Nische mit 2,0 W LED-Strahler, 6000 Kelvin, 1 Auszug 2 Glaseinlegeböden EEK A-A++</p> <p><i>medium cabinet incl. top 1 door, 1 open case with 2,0 W LED-spotlight, 6000 Kelvin, 1 extension 2 glass boards EEC A-A++</i></p>	40	148,8	17,6/ 34,8	MTNAL4FL MTNAL4FR	Links/ <i>left</i> Rechts/ <i>right</i>			
 <p>Glasregal inkl. Abdeckplatte 7 Glasböden</p> <p><i>glass shelf incl. top 7 glass boards</i></p>	33,8	148,8	15	MGR33F				

EEK/EEC=Energieeffizienzklasse/energy efficiency category

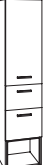
 Regalfarben unbedingt mit angeben, Übersicht siehe Seite 4. Please indicate shelf colours, overview see page 4.

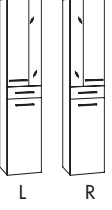
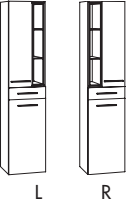
3260 »Beistellschränke/ side cabinets«









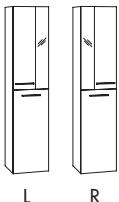

Beschreibung Description	Maße in cm Dimensions in cm			Artikel-Nr. Article no.	Türanschlag Door stop	Identnummer ID number		
	B/W	H	T/D			PG1 Dickkante/ thick edge	PG2 Matt/matt	PG3 Glanz/gloss
 <p>Hochschrank 2 Türen 4 Glaseinlegeböden</p> <p><i>tower cabinet 2 doors 4 glass boards</i></p>	30	178,7	34,8	HTT3L HTT3R HFTT4L HFTT4R HTT4L HTT4R	Links/left Rechts/right Links/left Rechts/right Links/left Rechts/right			
 <p>Hochschrank 2 Türen, 1 Einschubregal 4 Glaseinlegeböden</p> <p><i>tower cabinet 2 doors, 1 push-in shelf 4 glass boards</i></p>	40	178,7	34,8	HTET4L HTET4R	Links/left Rechts/right			
 <p>Hochschrank 1 Tür, 2 Auszüge, 1 Einschubregal 2 Glaseinlegeböden</p> <p><i>tower cabinet 1 door, 2 extensions, 1 push-in shelf 2 glass boards</i></p>	40	178,7	34,8	HTAAE4L HTAAE4R	Links/left Rechts/right			
 <p>Hochschrank 2 Türen, 1 Schubkasten 3 Glaseinlegeböden</p> <p><i>tower cabinet 2 doors, 1 drawer 3 glass boards</i></p>	40	178,7	34,8	HTST4L HTST4R	Links/left Rechts/right			
 <p>Hochschrank 1 Tür 1 Tür Kombination Holz/satiniertes Glas 1 Schubkasten, 3 Glaseinlegeböden</p> <p><i>tower cabinet 1 door 1 door combination wood/frosted glass 1 drawer, 3 glass boards</i></p>	40	178,7	34,8	HGST4L HGST4R	Links/left Rechts/right			
 <p>Hochschrank 2 Türen, 1 Einschubregal, 1 Schubkasten 3 Glaseinlegeböden</p> <p><i>tower cabinet 2 doors, 1 push-in shelf, 1 drawer 3 glass boards</i></p>	40	178,7	34,8	HTRST4L HTRST4R	Links/left Rechts/right			
 <p>Hochschrank 1 Tür, 1 Tür/Wäschekippe 2 Glaseinlegeböden</p> <p><i>tower cabinet 1 door, 1 door/linen bin 2 glass boards</i></p>	40	178,7	34,8	HTW4L HTW4R	Links/left Rechts/right			
 <p>Hochschrank 1 Tür, 3 Auszüge 2 Glaseinlegeböden</p> <p><i>tower cabinet 1 door, 3 extensions 2 glass boards</i></p>	40	178,7	34,8	HTAAA4L HTAAA4R	Links/left Rechts/right			

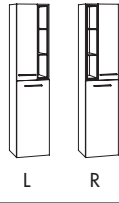
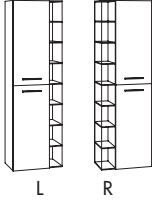
EEK/EEC=Energieeffizienzklasse/energy efficiency category

i Regalfarben unbedingt mit angeben, Übersicht siehe Seite 4. Please indicate shelf colours, overview see page 4

3260 »Beistellschränke/ side cabinets«





Beschreibung Description	Maße in cm Dimensions in cm			Artikel-Nr. Article no.	Türanschlag Door stop	Identnummer ID number		
	B/W	H	T/D			PG1 Dickkante/ thick edge	PG2 Matt/matt	PG3 Glanz/gloss

						PG1 Dickkante/ thick edge	PG2 Matt/matt	PG3 Glanz/gloss
	Hochschrank 1 Tür Kombination Holz/satiniertes Glas 1 Tür, 4 Glaseinlegeböden <i>tower cabinet 1 door combination wood/frosted glass 1 door, 4 glass boards</i>	40	178,7	34,8	HGT4L HGT4R	Links/left Rechts/right		
 	Hochschrank 2 Türen, 1 Einschubregal 4 Glaseinlegeböden <i>tower cabinet 2 doors, 1 push-in shelf 4 glass boards</i>	40	178,7	34,8	HTRT4L HTRT4R	Links/left Rechts/right		
	Hochschrank 2 Türen, 4 Glaseinlegeböden 1 seitl. Glasregal, 7 Glasböden <i>tower cabinet 2 doors, 4 glass boards 1 lateral glass shelf, 7 glass boards</i>	55	178,7	34,8	HTTGR55L HTTGR55R	Links/left Rechts/right		
 	Hochschrank 4 Türen 4 Glaseinlegeböden <i>tower cabinet 4 doors 4 glass boards</i>	60	178,7	34,8	HTT6			
	Hochschrank 4 Türen, 1 Einschubregal 4 Glaseinlegeböden <i>tower cabinet 4 doors, 1 push-in shelf 4 glass boards</i>	60	178,7	34,8	HTET6			
 	Hochschrank 2 Türen, 2 Auszüge, 1 Einschubregal 2 Glaseinlegeböden <i>tower cabinet 2 doors, 2 extensions, 1 push-in shelf 2 glass boards</i>	60	178,7	34,8	HTAAE6			
	Hochschrank 2 Türen, 3 Auszüge 2 Glaseinlegeböden <i>tower cabinet 2 doors, 3 extensions 2 glass boards</i>	60	178,7	34,8	HTAAA6			
	Hochschrank 4 Türen, 2 Schubkästen 4 Glaseinlegeböden <i>tower cabinet 4 doors, 2 drawers 4 glass boards</i>	60	178,7	34,8	HTSST6			

EEK/EEC=Energyeffizienzklasse/energy efficiency category

 Regalfarben unbedingt mit angeben, Übersicht siehe Seite 4. Please indicate shelf colours, overview see page 4.









3260 »Beistellschränke/ side cabinets«

Beschreibung Description	Maße in cm Dimensions in cm			Artikel-Nr. Article no.	Türanschlag Door stop	Identnummer ID number			
	B/W	H	T/D			PG1 Dickkante/ thick edge	PG2 Matt/matt	PG3 Glanz/gloss	
 <p>Kombi-Hochschrank 2 Türen, 1 Nische 4 Glaseinlegeböden</p> <p><i>tower cabinet 2 doors, 1 open case 4 glass boards</i></p>	40	178,7	17,6/ 34,8	HTNT4L HTNT4R	Links/left Rechts/right				
 <p>Kombi-Hochschrank 2 Türen, 1 Nische mit 2,0 W LED-Strahler, 6000 Kelvin 4 Glaseinlegeböden EEK A-A++</p> <p><i>tower cabinet 2 doors, 1 open case with 2,0 W LED-spotlight, 6000 Kelvin 4 glass boards EEC A-A++</i></p>	40	178,7	17,6/ 34,8	HTNTL4L HTNTL4R 	Links/left Rechts/right				
Hochschrank mit Spiegeltür/ tower cabinet with mirrored door - PEQ									
 <p>Hochschrank 2 Spiegeltüren 4 Glaseinlegeböden</p> <p><i>tower cabinet 2 mirrored doors 4 glass boards</i></p>	40	178,7	34,8	HPP4L HPP4R	Links/left Rechts/right				
	40	178,7	17,6	HFPP4L HFPP4R	Links/left Rechts/right				
 <p>Glasregal 7 Glasböden</p> <p><i>glass shelf 7 glass boards</i></p>	33,8	178,7	15	HGR33					

EEK/EEC=Energieeffizienzklasse/energy efficiency category

3260 »Regale/shelves«





Beschreibung Description	Maße in cm Dimensions in cm			Artikel-Nr. Article no.	Türanschlag Door stop	Identnummer ID number
	B/W	H	T/D			

 <p>i Winkelablage unten mit satiniertem Glasboden für Spiegelschrank/Spiegelpaneel inkl. Aufhänger</p> <p><i>Bottom angle shelf with frosted glass base for mirror cabinet/mirror panel incl. hanging brackets</i></p>	45	15,8	12,6	SRP45		
 <p>i Winkelablage unten mit satiniertem Glasboden für Spiegelschrank/Spiegelpaneel inkl. Aufhänger</p> <p><i>Bottom angle shelf with frosted glass base for mirror cabinet/mirror panel incl. hanging brackets</i></p>	60	15,8	12,6	SRP6		
 <p>i Regal für Montage unter Spiegelschrank/Spiegelpaneel oder frei hängend inkl. Aufhänger</p> <p><i>shelf for mounting under mirror cabinet/mirror panel or free hanging incl. hanging brackets</i></p>	45	17	15,6	SRB45		
 <p>i Regal für Montage unter Spiegelschrank/Spiegelpaneel oder frei hängend inkl. Aufhänger</p> <p><i>shelf for mounting under mirror cabinet/mirror panel or free hanging incl. hanging brackets</i></p>	60	17	15,6	SRB6		
 <p>i Regal für Montage unter Spiegelschrank/Spiegelpaneel oder frei hängend inkl. Aufhänger</p> <p><i>shelf for mounting under mirror cabinet/mirror panel or free hanging incl. hanging brackets</i></p>	80	17	15,6	SRB8		
 <p>i Regal für Montage unter Spiegelschrank/Spiegelpaneel oder frei hängend inkl. Aufhänger</p> <p><i>shelf for mounting under mirror cabinet/mirror panel or free hanging incl. hanging brackets</i></p>	90	17	15,6	SRB9		
 <p>i Regal für Montage unter Spiegelschrank/Spiegelpaneel oder frei hängend inkl. Aufhänger</p> <p><i>shelf for mounting under mirror cabinet/mirror panel or free hanging incl. hanging brackets</i></p>	100	17	15,6	SRB10		
 <p>i Regal für Montage unter Spiegelschrank/Spiegelpaneel oder frei hängend inkl. Aufhänger</p> <p><i>shelf for mounting under mirror cabinet/mirror panel or free hanging incl. hanging brackets</i></p> <p>60 cm 60 cm</p>	120	17	15,6	SRB12-66		

Alle Regale sind inkl. Aufhänger, Montage ist horizontal und vertikal möglich / all boards are incl. hanging brackets, mounting is possible horizontally and vertically.











i Regalfarben unbedingt mit angeben, Übersicht siehe Seite 4. Please indicate shelf colours, overview see page 4.

Beschreibung Description	Maße in cm Dimensions in cm			Artikel-Nr. Article no.	Türanschlag Door stop	Identnummer ID number
	B/W	H	T/D			









 	Regal für seitliche Montage oder freihängend, inkl. Aufhänger <i>shelf for side mounting or free-hanging incl. hanging brackets</i>	15	68,2	15,6	REB15	
 	Regal für seitliche Montage oder freihängend, inkl. Aufhänger <i>shelf for side mounting or free-hanging incl. hanging brackets</i>	20	68,2	15,6	REB20	

Alle Regale sind inkl. Aufhänger, Montage ist horizontal und vertikal möglich / all boards are incl. hanging brackets, mounting is possible horizontally and vertically.





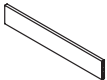
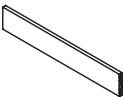

 Regalfarben unbedingt mit angeben, Übersicht siehe Seite 4. Please indicate shelf colours, overview see page 4.

Beschreibung Description	Maße in cm Dimensions in cm			Artikel-Nr. Article no.	Türanschlag Door stop	Identnummer ID number
	B/W	H	T/D			
 Handtuchhalter 1-armig (Befestigung am Schrank) <i>towel rail 1-arm (fastening on the cabinet)</i>	5	1	33	HHF133		
 Handtuchhalter 1-armig (Befestigung am Schrank) <i>towel rail 1-arm (fastening on the cabinet)</i>	5	1	33	HHF133S		
 Handtuchhalter 1-armig (Befestigung am Schrank) ausziehbar <i>towel rail 1-arm (fastening on the cabinet) pull out</i>	7,5	4	32,5/ 50	HH133		
 Handtuchhalter 2-armig (Befestigung am Schrank) ausziehbar <i>towel rail 2-arms (fastening on the cabinet) pull out</i>	10,5	4	32,5/ 50	HH233		
 Handtuchhalter verchromt (Befestigung am Schrank) <i>chromed towel rail (fastening on the cabinet)</i>	5	2,5	40	RHH		
 Spiegelschrank-Unterbaubeleuchtung 5,8 W LED EEK A-A++ (für Spiegelschrank ab 60 cm Breite), 6000 Kelvin Beleuchtung kann unter Spiegel- schränken und unter Regalen verbaut werden. <i>base lighting for mirror cabinet 5,8 W LED EEC A-A++ (for mirror cabinet ex 60 cm width), 6000 Kelvin Lighting can be installed under mirror cabinets and under boards.</i>	57			WTBP60		
 Spiegelschrank-Unterbaubeleuchtung 3,4 W LED EEK A-A++ (für Spiegel- schrank ab 80 cm Breite) 6000 Kelvin Beleuchtung kann nur unter Spiegel- schränke und nicht unter Regale verbaut werden. <i>base lighting for mirror cabinet 3,4 W LED EEC A-A++ (for mirror cabinet ex 80 cm width) 6000 Kelvin Lighting only can be installed under mirror cabinets and not under boards.</i>	70			WTB70		
 Spiegelschrank-Unterbaubeleuchtung 5,3 W LED EEK A-A++ (für Spiegelschrank ab 120 cm Breite) 6000 Kelvin Beleuchtung kann nur unter Spiegel- schränke und nicht unter Regale verbaut werden. <i>base lighting for mirror cabinet 5,3 W LED EEC A-A++ (for mirror cabinet ex 120 cm width) 6000 Kelvin Lighting only can be installed under mirror cabinets and not under boards.</i>	110			WTB110		

EEK/EEC=Energieeffizienzklasse/energy efficiency category

Beschreibung Description	Maße in cm Dimensions in cm			Artikel-Nr. Article no.	Türanschlag Door stop	Identnummer ID number
	B/W	H	T/D			
 <p>Waschtischunterschrankbeleuchtung 6,7 W LED, 4000/4500/6000 Kelvin umschalbar in 3 Lichtfarben, EEK A-A++ inkl. Schalter, für Unterschrank ab 80 cm Breite</p> <p><i>base lighting for washbasin cabinet 6,7 W LED, 4000/4500/600 Kelvin 3 switchable luminous colours EEC A-A++, incl. switch, for base cabinet ex 80 cm width</i></p>	70	2	1,5	WUTB72		
 <p>Schubkasteneinsatz (Kunststoff) für Schubkasten B: 40 cm / T: 30 cm für Beistellschränke</p> <p><i>drawer insert part (plastic) for drawer 40 cm w: 40cm / d: 30 cm for side cabinets</i></p>	30,9	4,5	28	SEG4		
 <p>Schubkasteneinsatz (Kunststoff) für Schubkasten 40 cm B: 40 cm / T: 40 cm für Waschtischunterschränke inkl. Ab- deckplatte</p> <p><i>drawer insert part (plastic) for drawer 40 cm w: 40cm / d: 30 cm for washbasin base cabinets incl. top</i></p>	30,9	4,5	38	SEG44		
 <p>Schubkasteneinsatz (Kunststoff) für Schubkasten 60 cm B: 60 cm / T: 30 cm für Beistellschränke</p> <p><i>drawer insert part (plastic) for drawer 60 cm w: 60cm / d: 30 cm for side cabinets</i></p>	50,9	4,5	28	SEG6		
 <p>Schubkasteneinsatz (Kunststoff) für Schubkasten 40 cm B: 60 cm / T: 40 cm für Waschtischunterschränke inkl. Abdeckplatte</p> <p><i>drawer insert part (plastic) for drawer 40 cm w: 60cm / d: 40 cm for washbasin base cabinets incl. top</i></p>	50,9	4,5	38	SEG64		
 <p>Inneneinteilung für 60 cm Auszug</p> <p><i>internal subdivison for 60 cm extension</i></p>	58	6	1,1	IEG60		
 <p>Inneneinteilung für 77 cm Auszug</p> <p><i>internal subdivison for 77 cm extension</i></p>	75	6	1,1	IEG77		
 <p>Inneneinteilung für 97 cm Auszug</p> <p><i>internal subdivison for 97 cm extension</i></p>	95	6	1,1	IEG97		
 <p>Inneneinteilung für 117 cm Auszug</p> <p><i>internal subdivison for 117 cm extension</i></p>	115	6	1,1	IEG117		

EEK/EEC=Energieeffizienzklasse/energy efficiency category

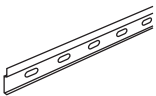
Beschreibung <i>Description</i>	Maße in cm <i>Dimensions in cm</i>			Artikel-Nr. <i>Article no.</i>	Türanschlag <i>Door stop</i>	Identnummer <i>ID number</i>
	B/W	H	T/D			
 <p>Designsiphon <i>design siphon</i></p>				DS		
 <p>Raumsparsiphon <i>basin siphon</i></p>				RSPAR-4		
 <p>Stellfuß verchromt 5x5 cm, 2-er Set Höhenverstellung +1 cm für Schrankhöhe 47,8 cm <i>adjustable feet chromed 5x5 cm, set of 2, adjustment range +1 cm for cabinet height 47,8 cm</i></p>		24,2		SFA4		
 <p>Stellfuß verchromt 5x5 cm, 2-er Set Höhenverstellung +1 cm für Schrankhöhe 60,6 cm <i>adjustable feet chromed 5x5 cm, set of 2, adjustment range +1 cm for cabinet height 60,6 cm</i></p>		10		SFB4		
 <p>Sockelstellfuß Chrom je 4 Stück/Pack <i>adjustable feet chromated 4 pcs/unit</i></p>		12/ 14		SF12C		
 <p>Spiegelheizung für Spiegelpaneel 35 W inkl. Schalter <i>mirror heater for mirror panel 35 W incl. switch</i></p>	50	30		SH		
 <p>Montageschiene inkl. Befestigungsmaterial <i>mounting rail incl. fastening material</i></p>	210			MS210		

EEK/EEC=Energieeffizienzklasse/energy efficiency category

3260 »Maße/dimensions«

Bohrlochhöhen für Schraubhaken, Anschlussmaße und Abflusshöhen/drilling point for screw hooks, dimensions for mounting and drain

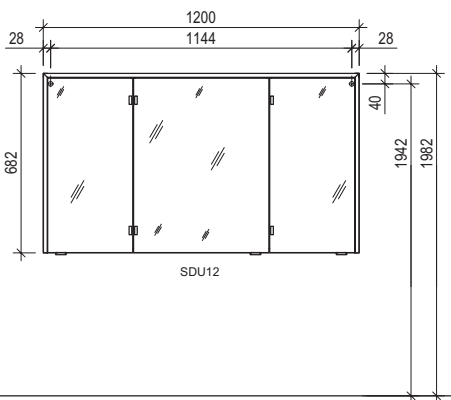
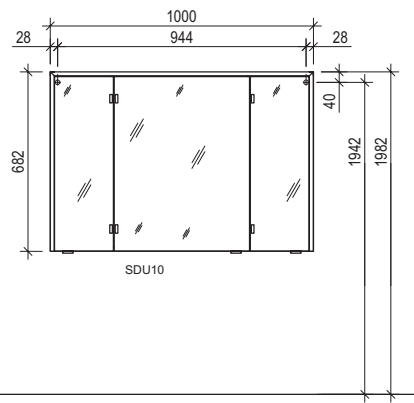
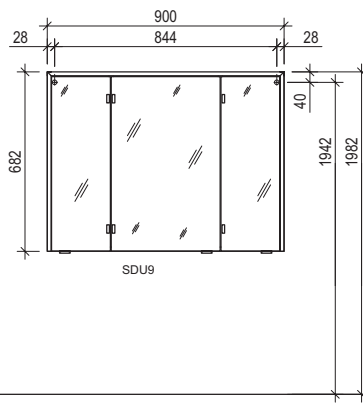
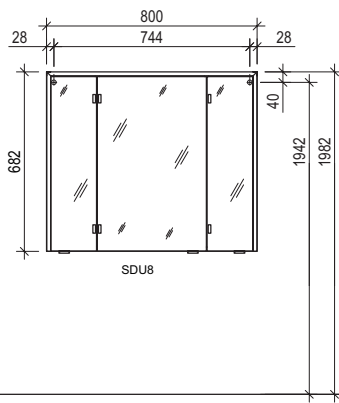
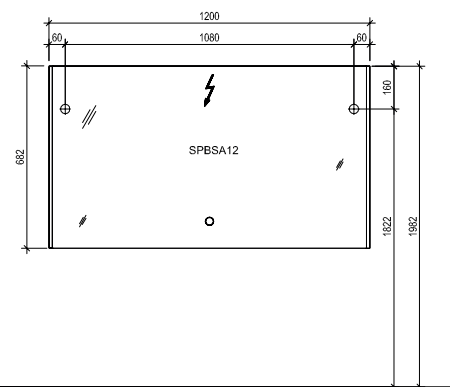
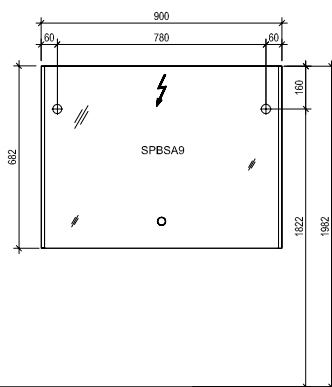
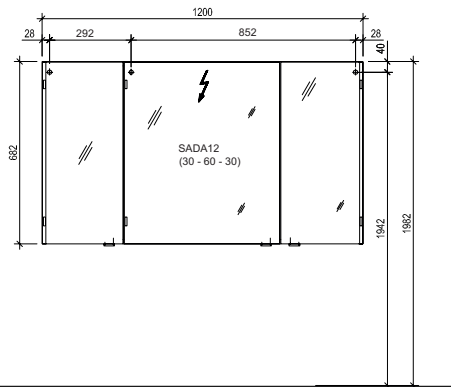
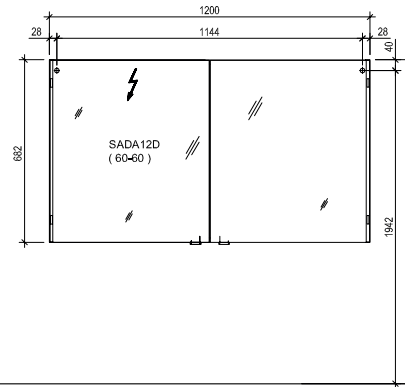
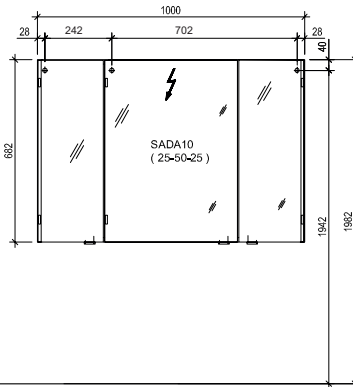
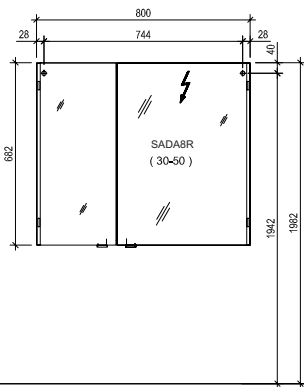

! Achtung: Die Montage muss durch fachkundige Personen erfolgen. Der Untergrund zur Wandbefestigung ist vor Montage zu prüfen. Bitte wählen Sie entsprechend das geeignete Befestigungsmaterial. Fehlerhafte Montagen können das Möbel beschädigen oder dessen Funktion dauerhaft beeinträchtigen. Für Sach- und Personenschäden übernehmen wir im Falle einer unsachgemäßen Montage keine Haftung.
 Attention: Assembly must be carried out by skilled personnel. The subsurface for the wall mounting must be checked before assembly. Please select a suitable mounting material. Faulty assembly can damage furniture or permanently impair its function. We will not be held responsible for damage to material or persons in the case of improper assembly.

3260 »Maße/dimensions«

Bohrlochhöhen für Schraubhaken, Anschlussmaße und Abflusshöhen/drilling point for screw hooks, dimensions for mounting and drain

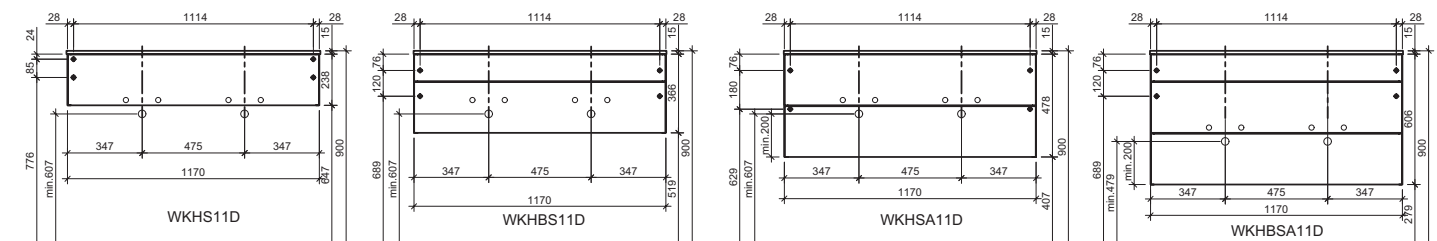
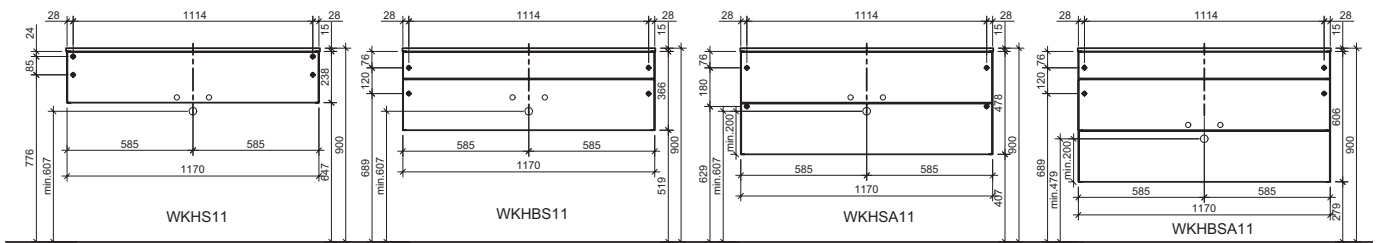
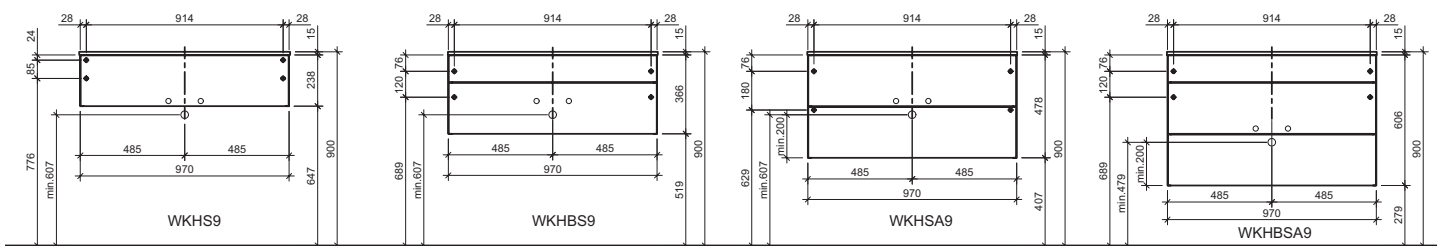
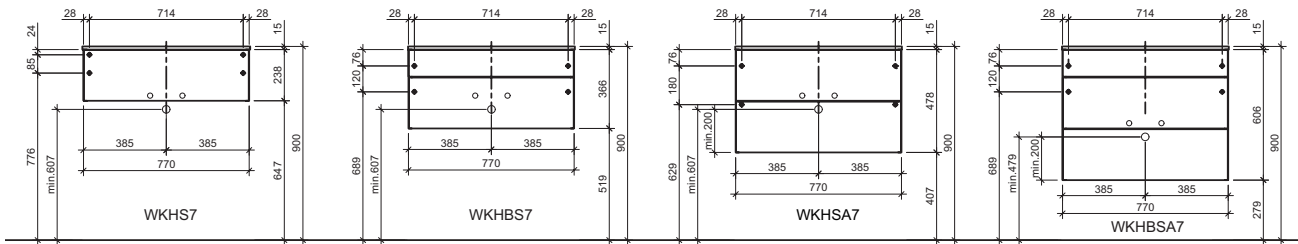

! Achtung: Die Montage muss durch fachkundige Personen erfolgen. Der Untergrund zur Wandbefestigung ist vor Montage zu prüfen. Bitte wählen Sie entsprechend das geeignete Befestigungsmaterial. Fehlerhafte Montagen können das Möbel beschädigen oder dessen Funktion dauerhaft beeinträchtigen. Für Sach- und Personenschäden übernehmen wir im Falle einer unsachgemäßen Montage keine Haftung.
 Attention: Assembly must be carried out by skilled personnel. The subsurface for the wall mounting must be checked before assembly. Please select a suitable mounting material. Faulty assembly can damage furniture or permanently impair its function. We will not be held responsible for damage to material or persons in the case of improper assembly.

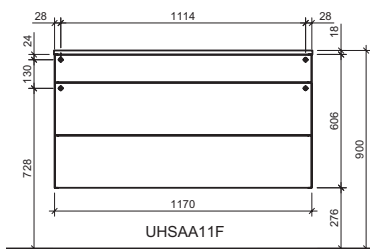
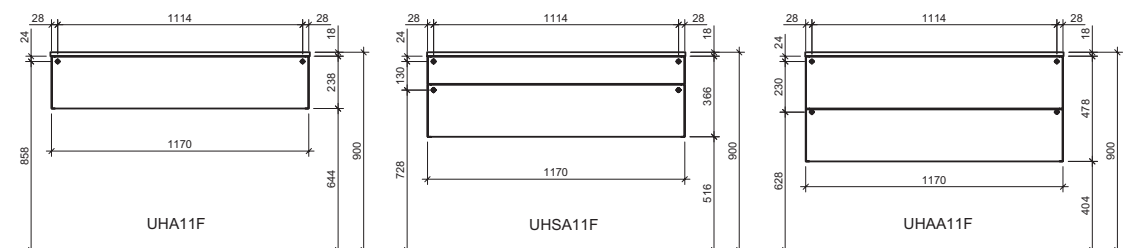
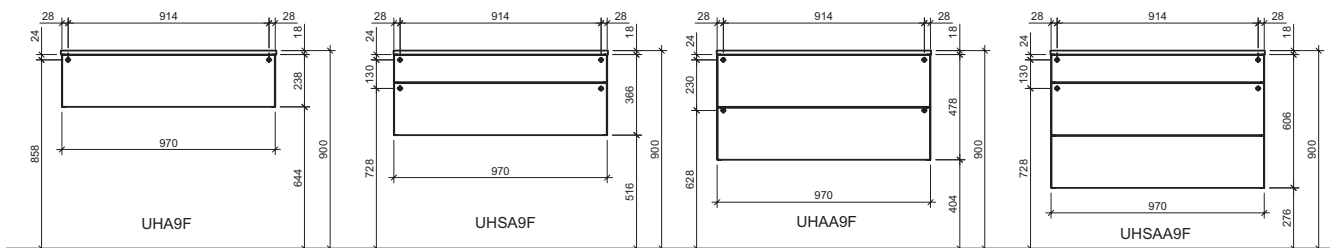
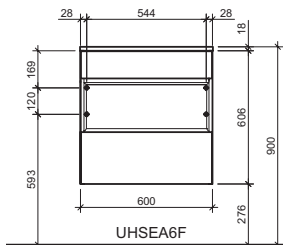
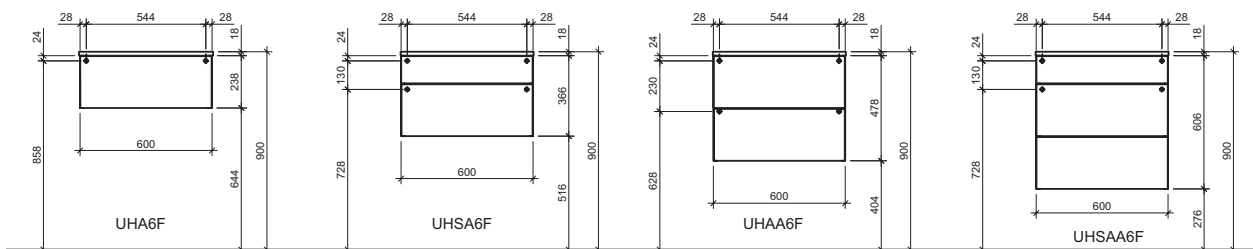
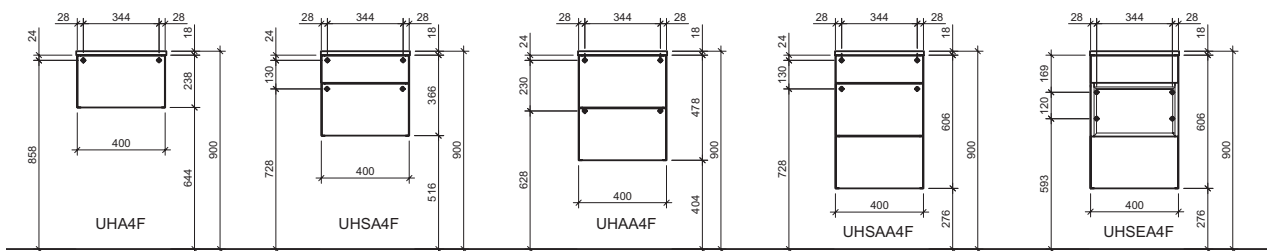

! Achtung: Die Montage muss durch fachkundige Personen erfolgen. Der Untergrund zur Wandbefestigung ist vor Montage zu prüfen. Bitte wählen Sie entsprechend das geeignete Befestigungsmaterial. Fehlerhafte Montagen können das Möbel beschädigen oder dessen Funktion dauerhaft beeinträchtigen. Für Sach- und Personenschäden übernehmen wir im Falle einer unsachgemäßen Montage keine Haftung.

Attention: Assembly must be carried out by skilled personnel. The subsurface for the wall mounting must be checked before assembly. Please select a suitable mounting material. Faulty assembly can damage furniture or permanently impair its function. We will not be held responsible for damage to material or persons in the case of improper assembly.

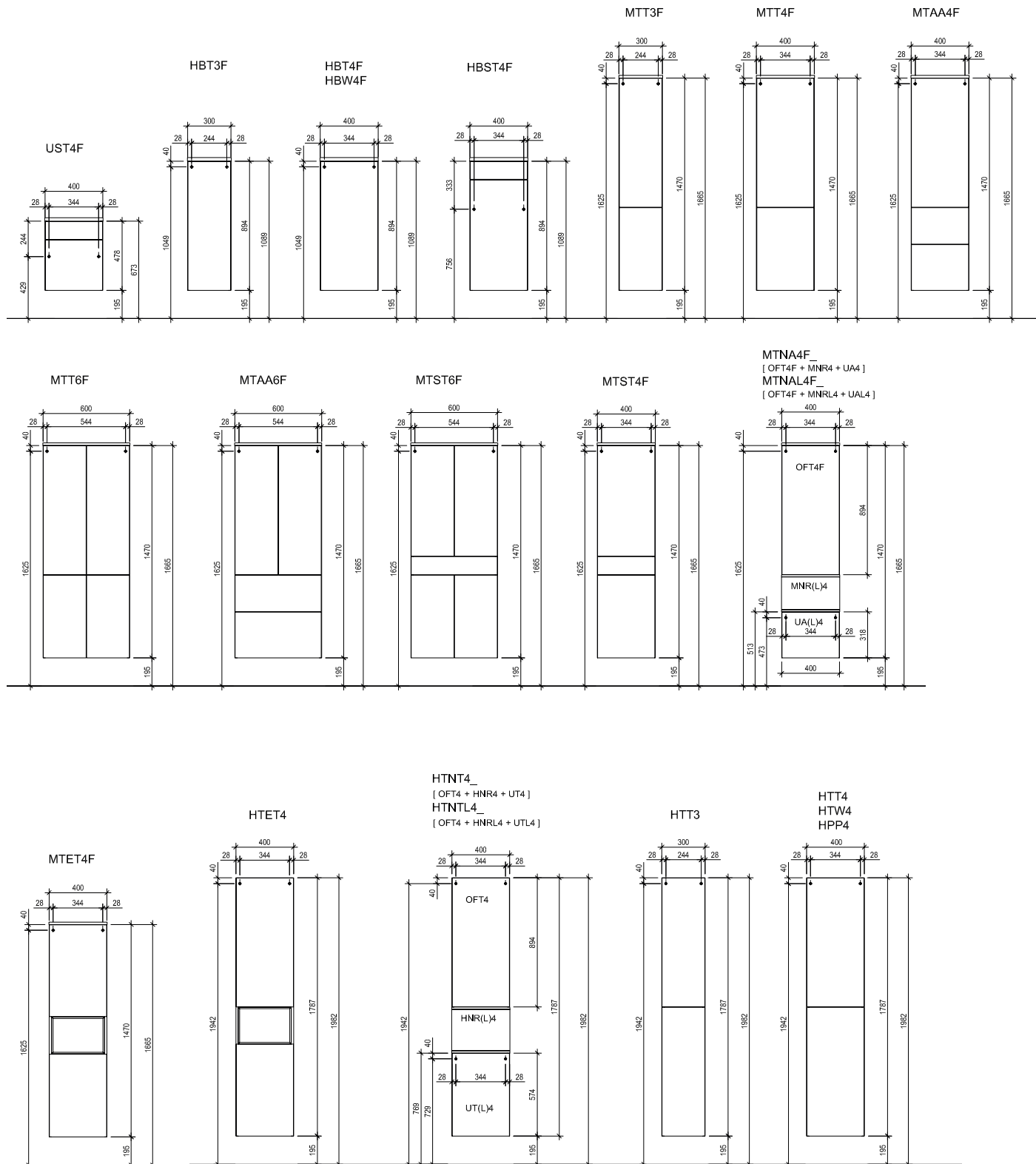

! Achtung: Die Montage muss durch fachkundige Personen erfolgen. Der Untergrund zur Wandbefestigung ist vor Montage zu prüfen. Bitte wählen Sie entsprechend das geeignete Befestigungsmaterial. Fehlerhafte Montagen können das Möbel beschädigen oder dessen Funktion dauerhaft beeinträchtigen. Für Sach- und Personenschäden übernehmen wir im Falle einer unsachgemäßen Montage keine Haftung.
 Attention: Assembly must be carried out by skilled personnel. The subsurface for the wall mounting must be checked before assembly. Please select a suitable mounting material. Faulty assembly can damage furniture or permanently impair its function. We will not be held responsible for damage to material or persons in the case of improper assembly.

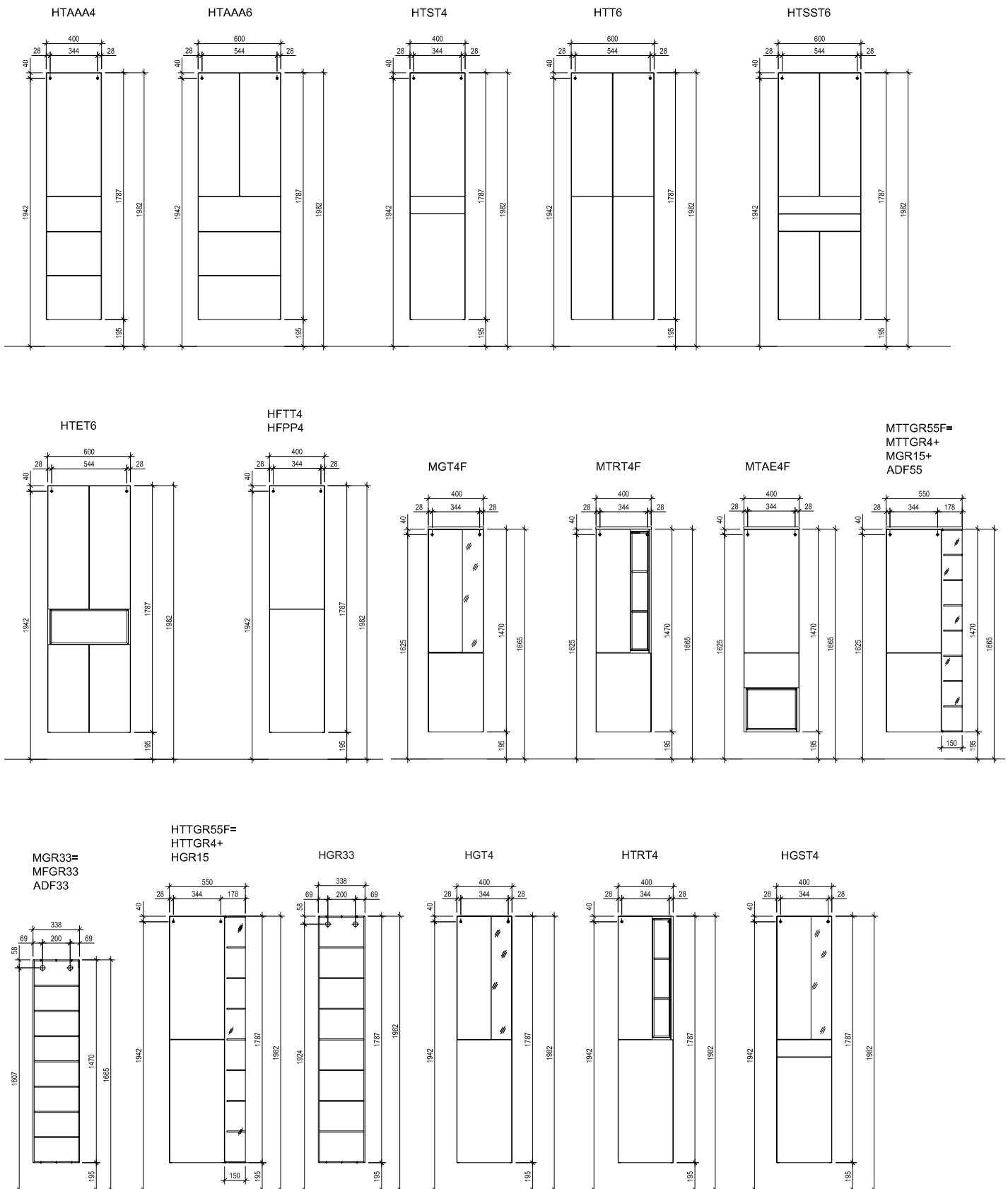

Achtung: Die Montage muss durch fachkundige Personen erfolgen. Der Untergrund zur Wandbefestigung ist vor Montage zu prüfen. Bitte wählen Sie entsprechend das geeignete Befestigungsmaterial. Fehlerhafte Montagen können das Möbel beschädigen oder dessen Funktion dauerhaft beeinträchtigen. Für Sach- und Personenschäden übernehmen wir im Falle einer unsachgemäßen Montage keine Haftung.

Attention: Assembly must be carried out by skilled personnel. The subsurface for the wall mounting must be checked before assembly. Please select a suitable mounting material. Faulty assembly can damage furniture or permanently impair its function. We will not be held responsible for damage to material or persons in the case of improper assembly.

3260 »Maße/dimensions«

Bohrlochhöhen für Schraubhaken, Anschlussmaße und Abflusshöhen/drilling point for screw hooks, dimensions for mounting and drain

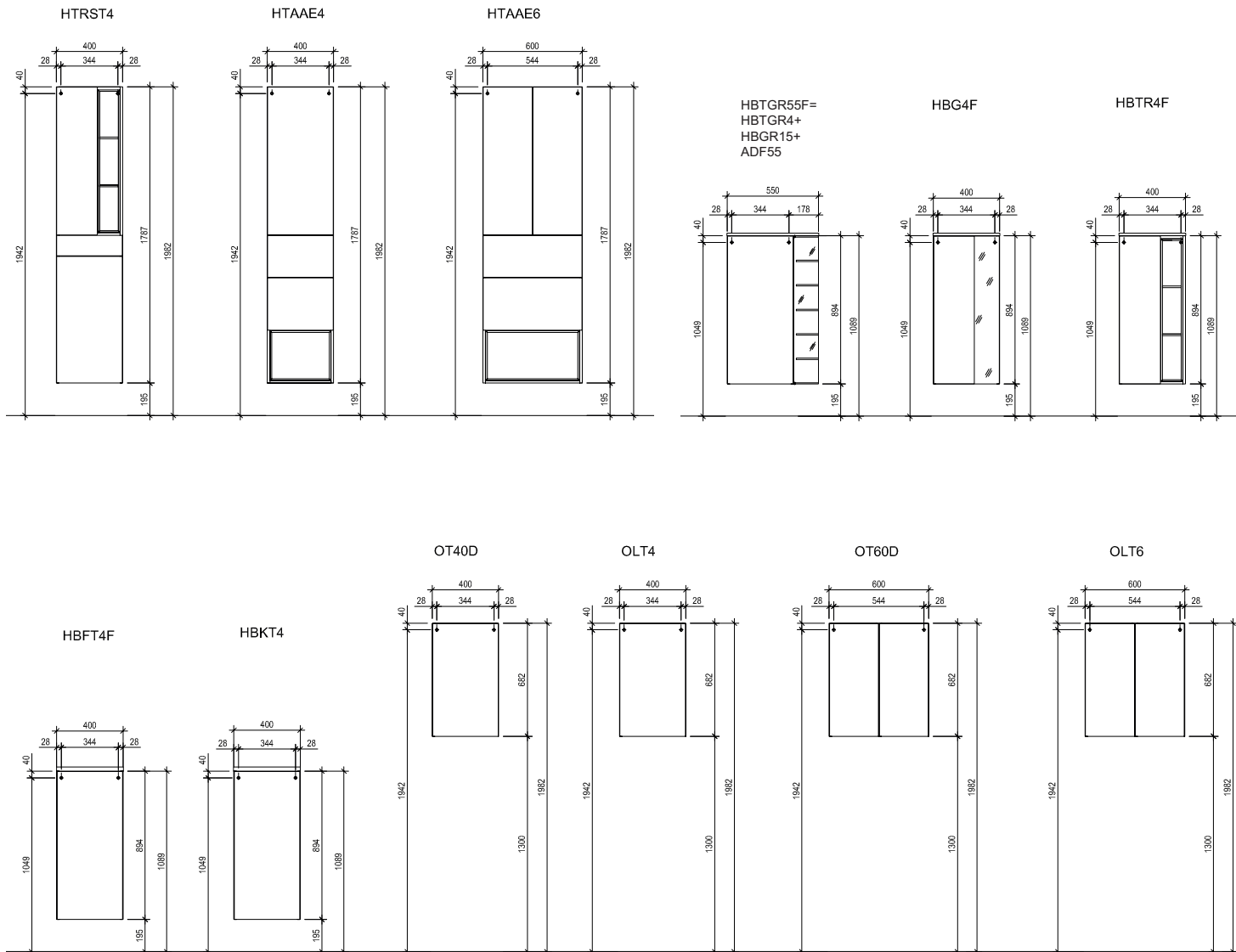

! Achtung: Die Montage muss durch fachkundige Personen erfolgen. Der Untergrund zur Wandbefestigung ist vor Montage zu prüfen. Bitte wählen Sie entsprechend das geeignete Befestigungsmaterial. Fehlerhafte Montagen können das Möbel beschädigen oder dessen Funktion dauerhaft beeinträchtigen. Für Sach- und Personenschäden übernehmen wir im Falle einer unsachgemäßen Montage keine Haftung.
 Attention: Assembly must be carried out by skilled personnel. The subsurface for the wall mounting must be checked before assembly. Please select a suitable mounting material. Faulty assembly can damage furniture or permanently impair its function. We will not be held responsible for damage to material or persons in the case of improper assembly.

3260 »Maße/dimensions«

Bohrlochhöhen für Schraubhaken, Anschlussmaße und Abflusshöhen/drilling point for screw hooks, dimensions for mounting and drain

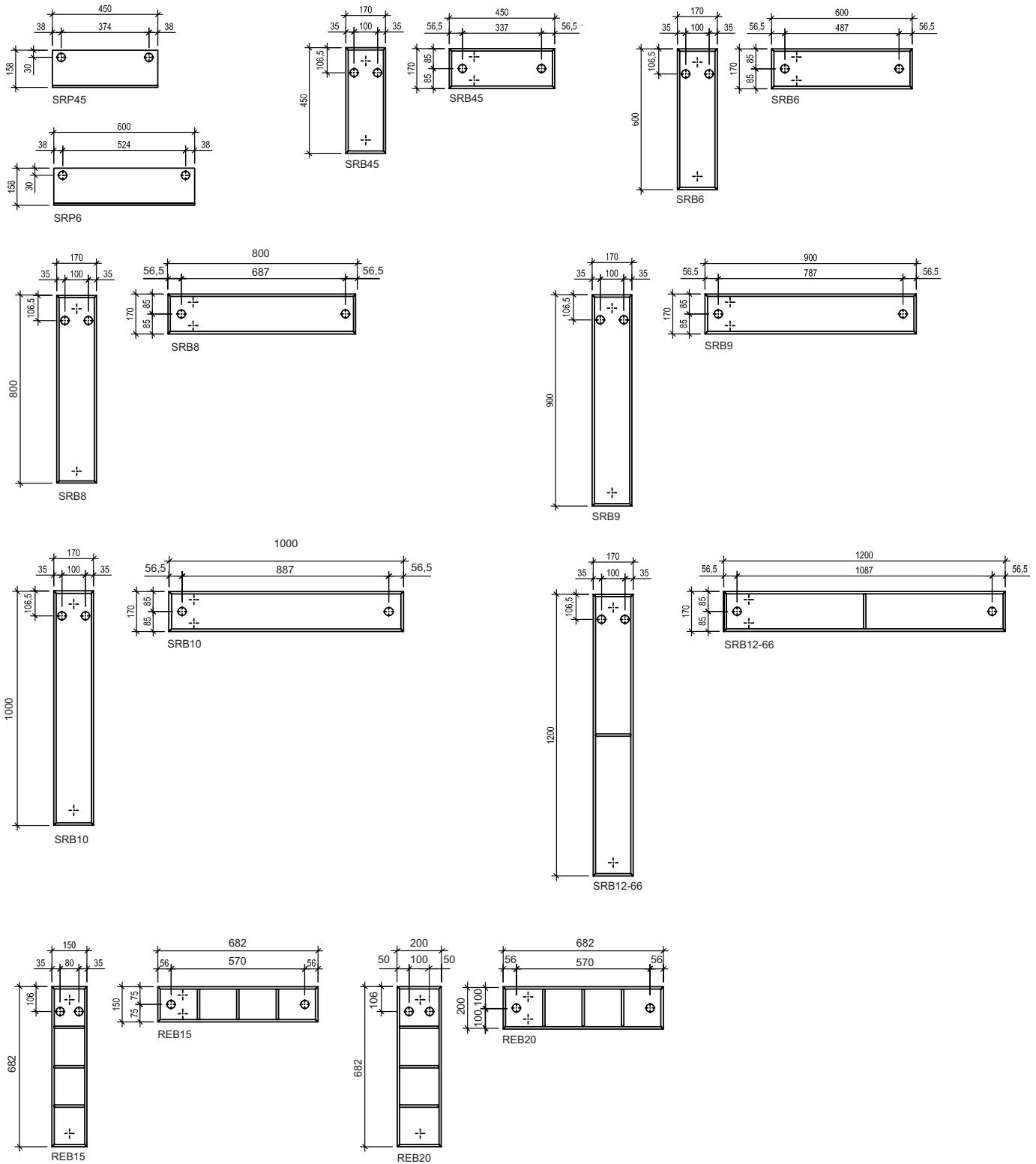

! Achtung: Die Montage muss durch fachkundige Personen erfolgen. Der Untergrund zur Wandbefestigung ist vor Montage zu prüfen. Bitte wählen Sie entsprechend das geeignete Befestigungsmaterial. Fehlerhafte Montagen können das Möbel beschädigen oder dessen Funktion dauerhaft beeinträchtigen. Für Sach- und Personenschäden übernehmen wir im Falle einer unsachgemäßen Montage keine Haftung.
 Attention: Assembly must be carried out by skilled personnel. The subsurface for the wall mounting must be checked before assembly. Please select a suitable mounting material. Faulty assembly can damage furniture or permanently impair its function. We will not be held responsible for damage to material or persons in the case of improper assembly.